

# TINY STEPS ROADSTER™

2-in-1 Activity Walker

**2 MODES**  
grow with your child



Electronic toy steering wheel  
with car sounds



Height-adjustable seat



Large grill with headlights offers  
a realistic automobile look

# Kolcraft®



Scan for instructional video  
Escanear para ver video instructivo



Escanee para obtener  
instrucciones en español

Consumer Service: 1.800.453.7673  
www.kolcraft.com

Model #: KW031  
W033-R4 09/2021

## WARNING

Read all instructions BEFORE assembly and USE of the walker. Failure to follow these warnings and instructions could result in serious injury or death. For your child's safety, read the labels and the instructions before using product. Keep instructions for future use.

### IMPORTANT SAFETY INFORMATION:

#### How to Keep Your Child Safe While Using this Product

- **NEVER** leave child unattended. Always keep child in view while **IN WALKER**.
- **CAUTION: Toys intended to be assembled by adult! Toys are intended to be played with while attached to the walker and are not intended to be played with when not attached to the walker.**
- **CHOKING HAZARD-Small parts. ADULT ASSEMBLY REQUIRED.**  
This package contains small parts which, before assembly, present a choking hazard to children under the age of three. Care should be taken during unpacking and assembly to insure that all small parts and plastic bags are accounted for and kept out of the reach of children. All fasteners should be fully tightened.

#### **STAIR HAZARD**

- Avoid serious injury or death. Block stairs / steps securely before using this walker.
- Use only on flat surfaces free of objects that could cause this walker to tip over. Never use near stairs, steps, thresholds, hills, roadways, or pools.
- To avoid burns, keep child away from hot liquids, stoves, radiators, space heaters, fireplaces, etc.
- Discontinue using this walker should it become damaged or broken.
- Never carry this walker with child in it. Never adjust seat while child is in product.
- **DO NOT** lift or carry by tray or toys.
- **DO NOT** use this walker until baby can sit up unassisted.
- To reduce the chance of child slipping out of seat, check that both feet of child touch the floor.
- Discontinue use of activity walker (seated stage) when your child can stand unaided, walk unassisted or lift the walker off of the floor.
- To maintain stopping performance, clean friction strips regularly with damp cloth.

#### **Only use this activity walker (seated stage) if your child MEETS ALL of the requirements below:**

1. Can support body weight with legs
2. Weight is between 15 and 26 pounds (6.8 and 11.8 kgs)
3. Height is less than 32 inches (80 cms) and child is not able to stand flat footed while in the walker.

## CAUTION

- To prevent battery leaks, which can burn skin and eyes:
- Remove batteries when storing product for a long time.
  - Discard old batteries promptly in accordance with local laws and regulations.
  - Always replace the entire set of batteries at one time.
  - Never mix old and new batteries, or batteries of different brands or types.

### CARE & MAINTENANCE

1. Plastic Parts: Wipe clean with mild soap and a damp cloth. Air dry.
2. Seat Pad: Machine wash in cold water in gentle cycle. DO NOT use harsh detergents or bleach. DO NOT dry clean. Air or hang dry.

NOTE: To maintain stopping performance, clean friction strips regularly with damp cloth.

## PARTS LIST



Tray



Grill



Sheet of Decals



Left Rear Leg



Right Rear Leg

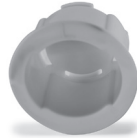

Left Rear Leg Locking Collar

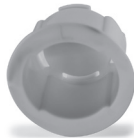

Right Rear Leg Locking Collar



Front Leg



Screws (4)



Hubcaps (4)



Back Tires (2)



Front Tires (2)



Seat Pad



Windshield Toy



Electronic Steering Wheel

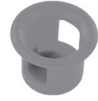

Steering Wheel Locking Cup



Rear Wheels (2)



Axles (2)



Front Casters (2)



Base

Tool Needed: Phillips screwdriver

Requires 2 AAA batteries (not included)

## To Adhere the Decals

1

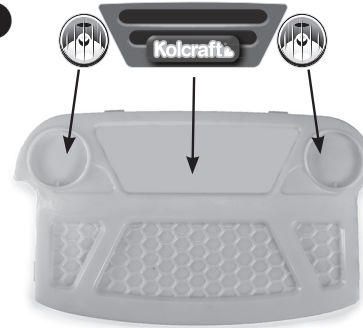

1 Place the headlight and grill stickers from the decal sheet as shown to the grill.

## To Attach Grill to Tray

1



1 Align the tabs of the grill with the slots on the front of the walker and snap into place.

## To Attach Legs to Tray

**1** Flip tray upside down, with the rear left tire well facing you, marked with an "L".

**2** Locate the left rear leg (as pictured) and place in the groove on the left tire well.

**3** Locate the left rear leg locking collar. Align the L on the lip of the collar with the L of the tray. Snap the collar through the tray, securing the leg to the tray.

Repeat steps 2 & 3 for rear right leg.

**4** Locate the front leg and place it in the front leg groove as shown, aligning the screw holes.

**5** Secure the front leg to the tray with screws in all four places. Pull up on front leg to make sure the leg is secure.

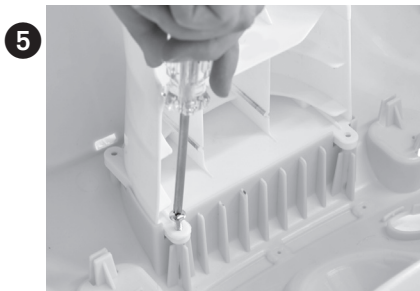
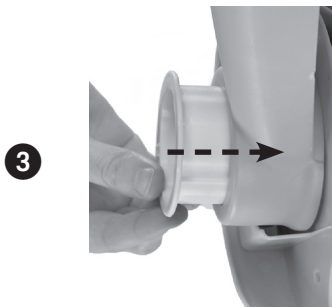
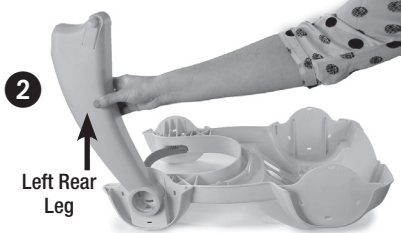

## To Attach Tires to Tray

**1** Snap 4 hubcaps into tires.

**2** Locate right back tire marked with an R. Fit tire into tire well marked with an R. Tire should slide easily over leg and securely snap into the tray. Repeat for other side.

**3** Locate 2 front tires. Align tire tabs with openings in tire well and snap securely into tray. Repeat for other side.



## To Attach Rear Wheels

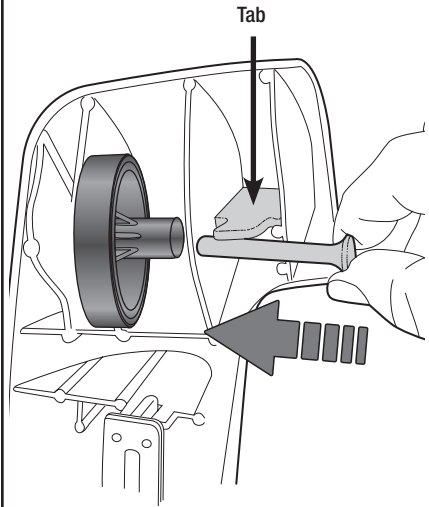

- 1 Flip base over to expose underside. Locate rear wheel opening in base of the walker.
- 2 Align holes of wheel with corresponding axle holes on the base of the walker. Plastic tab may need to be pushed to the side to expose the axle hole. The stem of the wheel should be facing the inside of the base.
- 3 Slide metal axle into holes from the inside towards the outside of the base until the head of the axle passes the plastic tab and the tab is able to hold the axle in place. Repeat for other wheel.

## Attach Front Casters

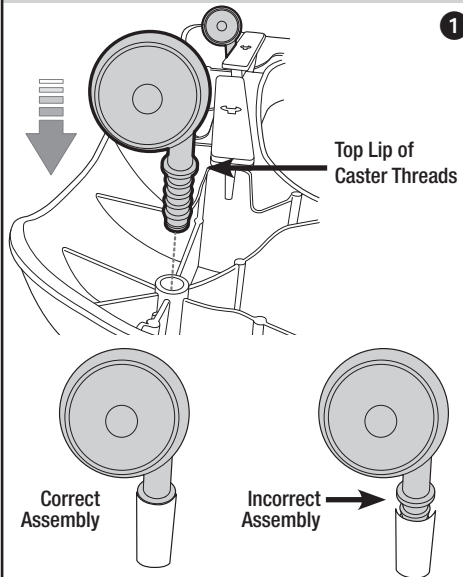

- 1 Insert the stem of one of the front casters into the hole in one of the front corners. Push firmly until the caster snaps (locks) into place. Pull up on caster to make sure it is locked in place.

**CAUTION:** Be sure the caster is inserted fully into the base. The top lip of the caster threads should be flush with the base hole. Nothing below this lip should be visible.

## To Attach Tray to Base

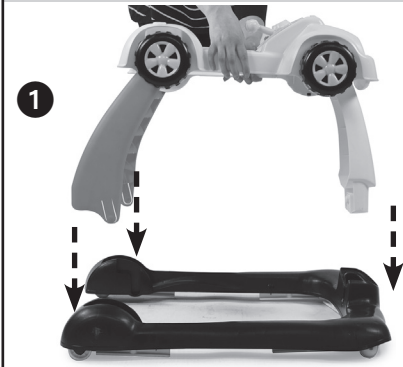

- 1 Position assembled tray on top of base into appropriate slots.

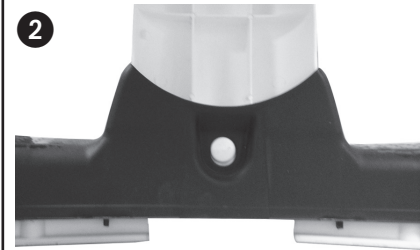

- 2 Snap front leg into place. Pull up on the tray to make sure the tray and base are secure.



- 3 Push rear leg tab in and snap into place. Repeat with other rear leg.

## To Attach Windshield Toy

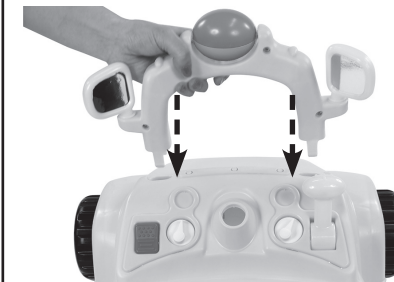

- 1 Take the windshield toy and snap into place on top of dashboard.

## To Install Batteries in Electronic Steering Wheel

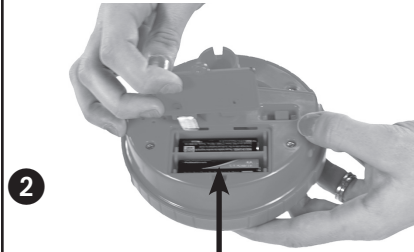

**1** To insert batteries, use a Phillips screwdriver to unfasten battery cover located on the bottom of the electronic toy steering wheel.



**2** Requires 2 "AAA" batteries (Not Included). Insert batteries as shown. Secure battery cover.

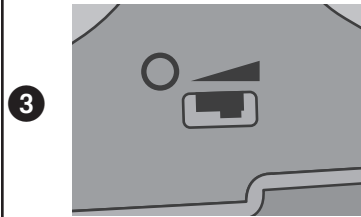

**3** This toy has 2 levels of volume. Move switch to the middle position for low volume and to the far right for high volume. To turn off, move switch to "0" position.

## To Attach Electronic Steering Wheel Toy

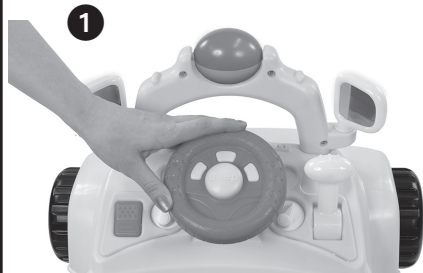

**1** Place the steering wheel toy into the hole on the dashboard.



**2** Locate the steering wheel locking cup and snap over bottom of steering wheel on underside of tray. Two tabs will lock cup into place.

**3** To Replace Batteries and Remove the Steering Wheel Toy: Push two tabs in and remove steering wheel locking cup. Pull up on steering wheel toy to remove.

## To Attach Seat Pad to Tray



**1** Push crotch portion of the seat pad inside out to form seat, so that the fabric is below the seat back.

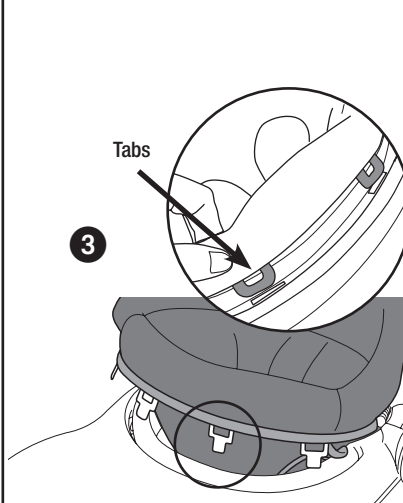

**2** Place seat pad into seat ring located on tray. Align it so that the highest point of the seat pad aligns with back of walker ring.

**3** Insert the 4 tabs on the seat pad into slots located around the front of the seat ring. Slide tabs through holes.

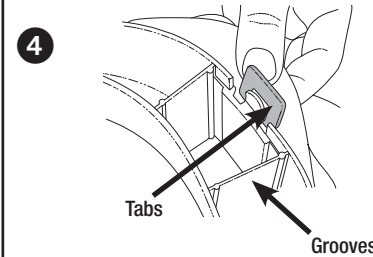

**4** Underneath the tray, pull tabs and align into grooves.

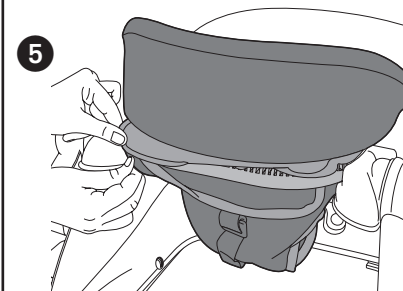

**5** Velcro the back of the seat pad around the rear of the seat ring.

**Test:** Push down hard on seating area of seat pad to make sure seat is securely in place.

**CAUTION:** Do not use walker if all tabs and Velcro are not secured properly, otherwise child may fall through walker.

## To Adjust Seat Pad Height

**NOTE:** As your child begins to grow, adjust height of walker via the seat pad so that their feet touch the ground when seated. To determine correct height after assembly, place child in walker and make sure both feet touch the ground. Always make sure seat pad is adjusted to the correct height position before placing child in product.

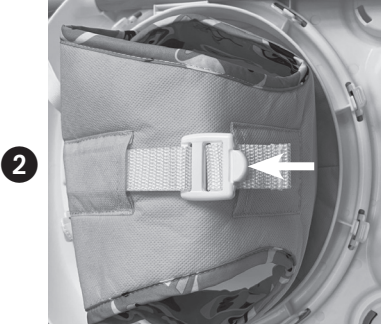

- 1 After seat pad is attached to tray, flip unit upside down to access the restraint strap on underside of seat pad.
- 2 Please note, to ensure proper operation, you will need to periodically adjust the seat restraint to accommodate your child's increased height. For **smaller babies**, seat pad should be extended to its lowest position. To adjust seat height, push button in on restraint strap to release restraint.
- 3 As baby grows, raise seat by tightening belt. This helps to prevent the child from placing their feet flat on ground and prevents your child from climbing out.

## To Convert to Walk-Behind Walker



- 1 Remove the seat pad by unfastening the 4 seat tabs from the tray and unsnapping the rear of the seat pad.
- 2 Your child can now stand behind the walker, using the texturized handle grip for support as they learn how to walk in the walk-behind mode.

Please direct any comments, questions or replacement part requests to:  
Kolcraft® Consumer Service Department  
1100 W Monroe St. Chicago, IL 60607  
1-800-453-7673 in U.S., 1-312-361-6315 outside U.S.  
8 am-5 pm (CT) Monday - Thursday, 8 am - 3 pm Friday (CT)  
e-mail: [customerservice@kolcraft.com](mailto:customerservice@kolcraft.com)